



FLOORING
ACCESSORIES
WORKTOPS



 **Teragren**®

THE AUTHORITY
IN BAMBOO

THE TERAGREN DIFFERENCE

Designed To Last For Generations

Bamboo has been used as a building material worldwide for generations. It offers a tensile strength greater than steel, withstands compression better than concrete, and is more resistant to moisture than hardwoods. These inherent qualities, however, can only be taken advantage of with a proper harvesting and manufacturing process. At Teragren we use only Optimum 5.5 Moso bamboo, derived from one of the hardest varieties with dense fibers that make for strong timber and beautiful, durable bamboo building products.

Optimum 5.5® refers to the age at which the bamboo is harvested, between 5-1/2 to 6 years, when full growth has been reached and its fibers are at peak density. By using only Optimum 5.5® Moso bamboo, we ensure that our products are harder and more stable for lasting performance. Bamboo harvested sooner is certainly cheaper, but results in softer fiber and a less stable finished product.

We can guarantee the quality of our products through direct control over a vertical supply chain with a single factory partner in China, who we have worked with for almost 20 years. Designed to last for generations, all Teragren products undergo independent quality testing on a regular basis.

In 1994, Teragren pioneered the bamboo building materials industry in the United States. Our founding mission was to help reduce dependence on dwindling timber resources by manufacturing high-quality bamboo products from sustainably harvested moso bamboo. We were founded on a business model focusing on quality, consistency and service – and a dedication to environmentally and socially responsible practices.

A core component of our mission is to become carbon negative. Our headquarters in Washington State is carbon neutral, and carbon measurement is underway at our factory partner in China and throughout our transportation system.

RELAX, It's Teragren Bamboo

Teragren flooring delivers a platform for living your life with peace of mind. Our proprietary manufacturing adhesive tests at formaldehyde emission levels far below those allowed by the strictest standards in the world, and our water-based, solvent-free finish is gentle on the environment. All of our flooring is certified by FloorScore®, the most stringent indoor air quality standard in the world, and qualifies for use in high performance schools and offices. Testing and Certification information is available on our website (teragren.com).

Our flooring carries a lifetime structural warranty, as well as a 25-year residential finish warranty*, and is easy to install. Both our Portfolio and Studio collections feature a patented glueless locking system with wider, longer planks for faster installation. View the DIY video on teragren.com

Floor to Ceiling Bamboo Design

Our beautiful and complete lines of bamboo flooring, panels, veneer, worktops and accessories are ideal for any décor, from contemporary to traditional. Coordinating accessories are available for your convenience, and affordable options in both strand and traditional construction are designed to meet your budget.

From the unique look of our strand bamboo, to the natural inherent color variation and subtle tones of our traditional products, Teragren can provide you with a sustainable and home-healthy option for every room.



I wish I had installed these floors years ago! Best home improvement we have ever done.
– L. Hammill, Hesperia, CA



Environmentally Smart

Our bamboo is sustainably grown in managed forests by independent farmers in Zhejiang Province, China. We pay fair-market value for bamboo culms that are renewably harvested over and over from the same root stock, providing farmers and their families with a stable income. Forest Stewardship Council certified products are available by special order and are delivered through a FSC Chain-of-Custody-certified distribution channel.

Bamboo forests absorb more CO₂ per acre than a comparable hardwood forest, and also release 35% more oxygen. No more than 25% of the CO₂ sequestered in Teragren products is emitted during their transport to market; the remaining 75% of sequestered carbon is permanently locked up within the products, reducing CO₂ levels in the atmosphere.

Teragren is recognized as a sustainable business category leader— named by Inc. Magazine as one of “The Green 50” companies setting the standard for environmentally friendly businesses, and one of the “Top Ten Greentrepreneurs” by Seattle Metropolitan Magazine. All Teragren bamboo products contribute to certification under the U.S. Green Building Council’s LEED® rating system in one or more categories.



The mark of responsible forestry



STUDIO flat grain Caramelized

Strand Bamboo Flooring

-  *PORTFOLIO COLORS*
-  *PORTFOLIO NATURALS*
-  *SYNERGY® WIDE PLANK*
-  *SYNERGY® MPL*
-  *SYNERGY® 72*

Coordinating Accessories

Coordinating Strand and Traditional bamboo stair parts and flooring trim for the finishing touch.

**Does not apply to Elements*

Traditional Bamboo Flooring

-  *STUDIO*
-  *CRAFTSMAN II*
-  *SIGNATURE COLORS*
-  *SIGNATURE NATURALS*
-  *ELEMENTS*

Ecosmart Worktops

A beautiful and durable alternative to traditional hardwoods for any work surface including countertops, kitchen islands and table tops.

PORTFOLIO COLLECTION

Our Portfolio Collection of strand bamboo flooring features 14 beautiful and distinct finishes. Installation is simple and straightforward with the patented Välinge 2G fold-down, self-locking system. Just drop and lock each plank into place for a tight, clean seam that doesn't require glue, staples, or nails - *View the DIY video on teragren.com*

Coordinating stair parts and trim are available for all products. *Visit teragren.com for more information.*

The colors, grains and textures in Portfolio Colors strand bamboo flooring provide you with choices for designing every project. Find favorites that complement your décor in our collection of 10 distinctive styles. A variety of colors and textures provide the perfect place to start when designing your dream home from the floor up.

DIMENSIONS

1/2" x 5" x 72 1/2" (12mm x 126mm x 1840mm)

LEED® CREDITS

MR6, IEQ 4.3

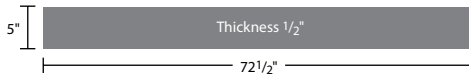

Micro-bevel on all four sides. Each box contains all 72 1/2" lengths.

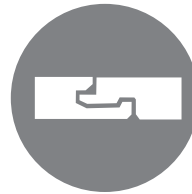

Välinge-patented 2G fold-down self-locking system

DESIGNING with Teragren

Discover The Unlimited Design Potential of Beautiful, High Quality Bamboo Flooring And Create Rooms That Invite You To Stay.

The foundation for the design of every room is a beautiful floor, and creative designing begins with the Teragren™ Color Palette Advisor. With our easy-to-use online Color Palette Advisor you can compare paints, fabrics, tiles, and texture elements that complement our Portfolio Colors Collection of flooring. From the floor up you'll be inspired to create inviting, distinctive and comfortable living spaces.

TERAGREN™ COLOR PALETTE ADVISOR	
SMOOTH PATINA	Brown Sugar
	Paris Black
	Rich Cognac
	Midnight Black
HANDSCRAPED	Darby Brown
	Hewn Port
NATURAL TEXTURES	Hewn Tawny
	High Tea
	New Country
	Honey Ridge



PORTFOLIO Brown Sugar

SMOOTH PATINA

Brown Sugar

A burnt caramel backdrop with beautiful light and dark highlights for functional areas of your home.

Industrial, clean, neutral: Charcoal, grey tweed, steel, stone, white



PORTFOLIO COLORS, Strand with Xcora™ technology, prefinished, wide-plank with self-locking system, 5" x 1/2" x 72-1/2"

SMOOTH PATINA

Paris Black

A fascinating deep black, highlighted with streaks of brown, adds instant drama to any room of your home.

Earthy neutrals:
Espresso, cocoa brown, charcoal, light grey

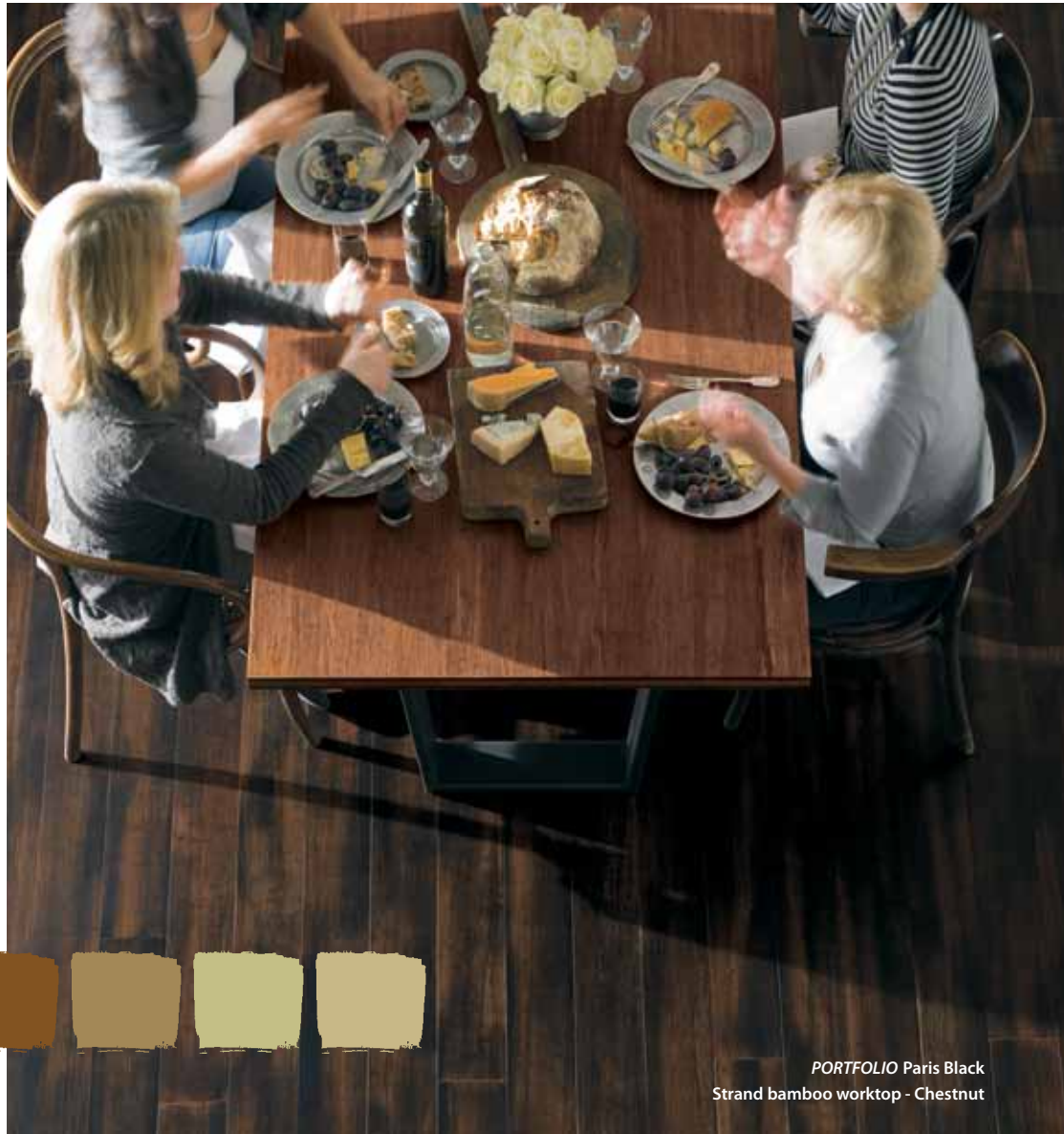

PORTFOLIO Paris Black
Strand bamboo worktop - Chestnut



SMOOTH PATINA

Rich Cognac

A deep, sophisticated Old World brown with a lovely, understated natural wood grain texture.

Inviting, serene, elegant:
Wisteria blue, sapphire, periwinkle, violet, camel brown, antique wood, ivory



PORTFOLIO Rich Cognac

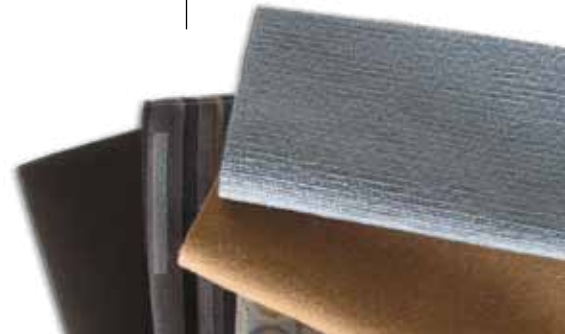



PORTFOLIO Midnight Black



SMOOTH PATINA

Midnight Black

A striking, deep black that provides the perfect foundation to highlight each room as a work of art.

Bold, sophisticated: Red, crimson, red-purple, cornsilk, blonde

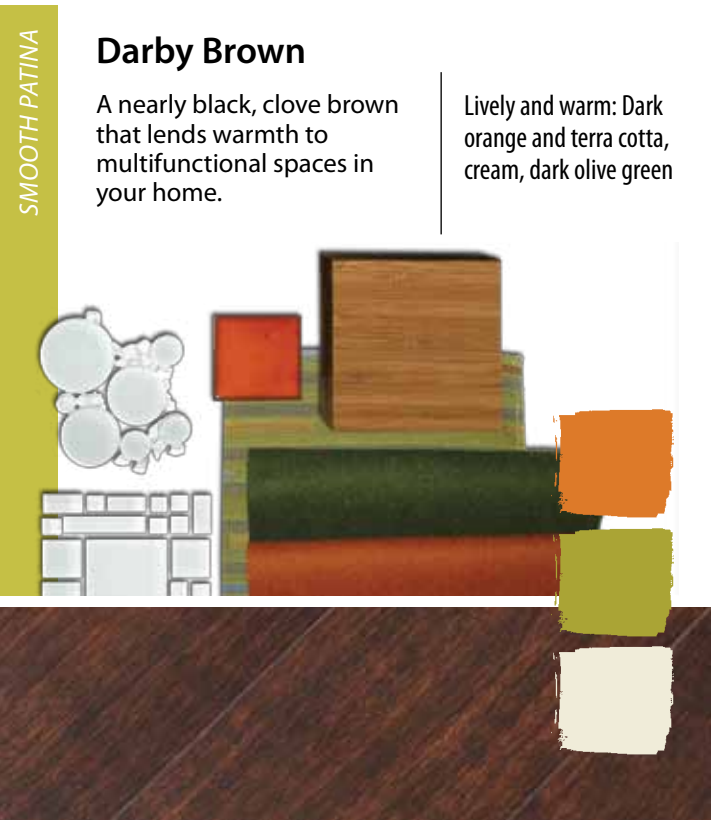
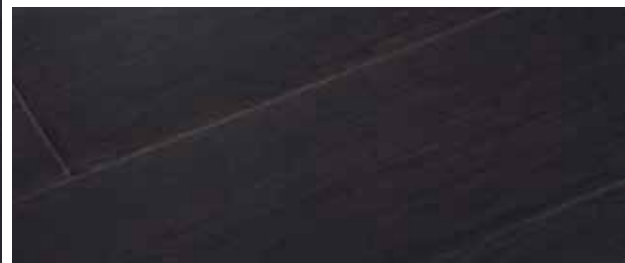

Darby Brown

A nearly black, clove brown that lends warmth to multifunctional spaces in your home.

Lively and warm: Dark orange and terra cotta, cream, dark olive green



PORTFOLIO Darby Brown

SMOOTH PATINA



HANDSCRAPED

Hewn Port

A beautifully unique handscraped and glossy brown, enriched with burgundy wine-colored tones.

Light, airy, romantic: Wine, amethyst, plum, heather, beige, cream, pearl, white, fresh green



PORTFOLIO Hewn Port



HANDSCRAPED

Hewn Tawny

A handscraped and glossy golden brown with a traditional, rustic feel that lends a sense of brightness and light to a room.

Light-reflective goldens: yellow ochre, butternut squash, gold, lilac, light stone

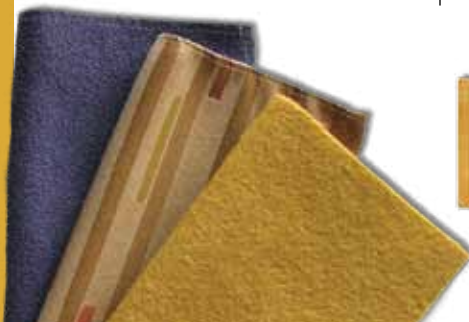

PORTFOLIO Hewn Tawny





NATURAL TEXTURES

High Tea

A pitted and dark flecked brown with warm auburn tones that warm up a room.

Fresh and natural: Green, leaf, olive, sienna, brown, cream, pale pink



PORTFOLIO High Tea

NATURAL TEXTURES

New Country

A unique golden sand with dark-flecks that serves as a great camouflage in high-traffic areas.

Rich desert tones: Burnt orange, lava red, sepia, bone, stoneware, tan



PORTFOLIO New Country



PORTFOLIO Honey Ridge

NATURAL TEXTURES

Honey Ridge

A pitted and flecked dark honey with warm wood tones and a rustic feel that is ideal for high-traffic areas.

Primary colors:
Red, gold, pencil yellow, blue, white



Our four distinct strand blends are now available on the Portfolio platform – an established look combined with durability and ease of installation.

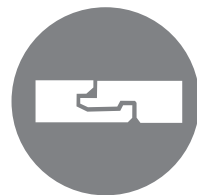

Välinge-patented 2G fold-down self-locking system

DIMENSIONS

1/2" x 5" x 72 1/2" (12mm x 126mm x 1840mm)

LEED® CREDITS

MR6, IEQ 4.3,

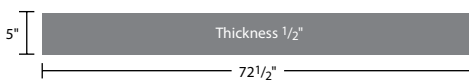

Micro-bevel on all four sides. Each box contains all 72 1/2" lengths.



PORTFOLIO NATURALS Chestnut

SYNERGY® WIDE PLANK, Strand with Xcora™ technology, prefinished, 7-11/16" x 9/16" x 72"

SYNERGY® floating floor with Xcora™ is 154% harder than red oak, and the wider, longer, square-edged planks lock together quickly, and complement a variety of decors.

(195mm x 14mm x 1830mm)

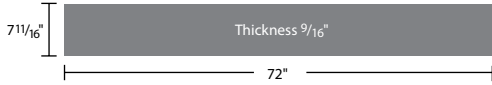

- Square edges on all four sides
- Each box contains all 72" lengths
- Välinge-patented self-locking system

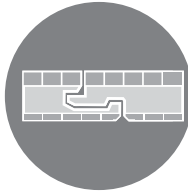

U.S. Patent No. 7,836,655
100% bamboo cross-ply engineered construction for greater stability.

SYNERGY® MPL

Strand with Xcora™ technology, prefinished, solid-strip, 3-3/4" x 1/2" x 24", 36", 48" and 72"

SYNERGY® strand solid-strip flooring offers a random visual in multiple precise lengths. Exclusive Xcora™ technology makes Synergy® perfect for high-traffic residential and commercial use - 154% harder than red oak.

- Micro-bevel on all four sides
- Tongue and groove
- Nail or glue down

(96mm x 12mm x 610mm, 915mm, 1220mm, 1830mm)

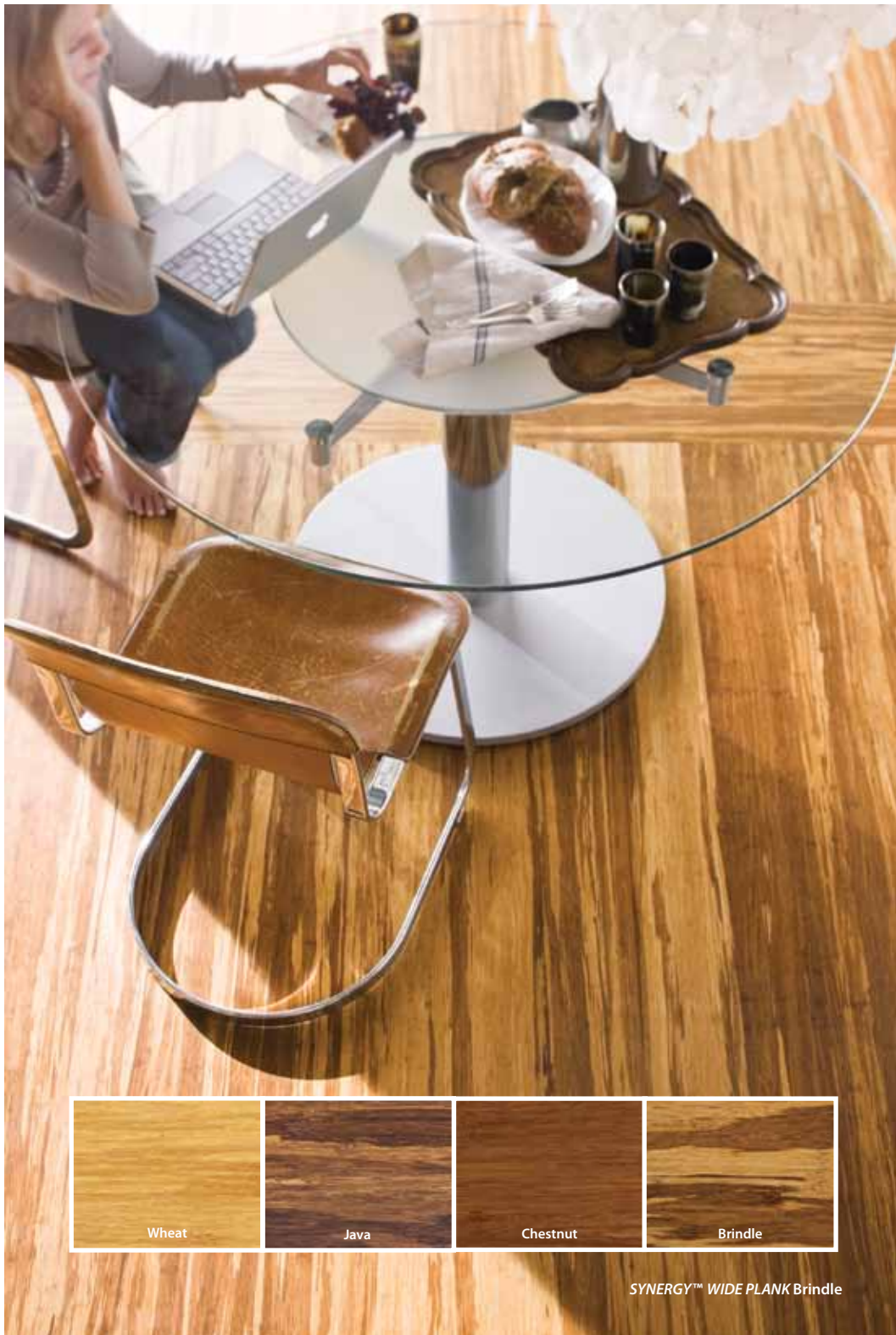
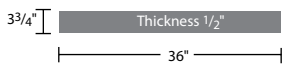

SYNERGY™ WIDE PLANK Brindle

SYNERGY® 72 Strand with Xcora™ technology, prefinished, solid strip, 3-3/4" x 3/8" x 72"

SYNERGY® strand solid-strip bamboo flooring in six-foot lengths is designed to provide homeowners with optimal affordability, and a high-quality and long-lasting floor.

- Micro bevel on all four sides
- Tongue and groove
- Recommended glue down only

(96mm x 10mm x 1830mm)



STUDIO, Traditional, prefinished, wide-plank with self-locking system, 7-11/16" x 9/16" x 75"

Studio is ideal for offices as well as residential installations. Square-edged wide planks offer a seamless look and the glueless, self-locking installation is fast and easy. 25% harder than red oak; 12% harder than maple.

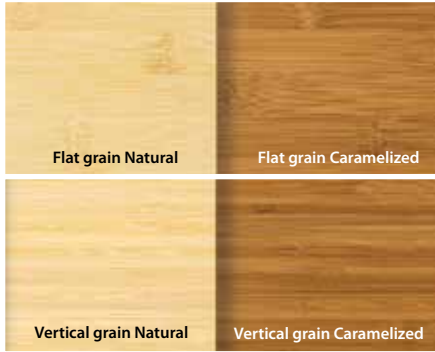

(195mm x 14mm x 1905mm)

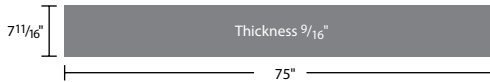

- Square edges on all four sides
- Each box contains all 75" lengths
- Välinge-patented self-locking system

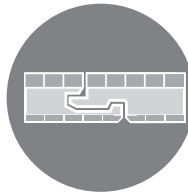

U.S. Patent No. 7,836,655
100% bamboo cross-ply engineered construction for greater stability.

I had many samples of various woods and bamboo and I literally beat the daylights out of each. The Teragren bamboo was just as strong as the Brazilian hardwoods I was looking at and just as pretty. Teragren's bamboo is sustainably sourced and the finishes adhere to strict safety standards.

- <http://ecomamasguidetolivinggreen.blogspot.com/>

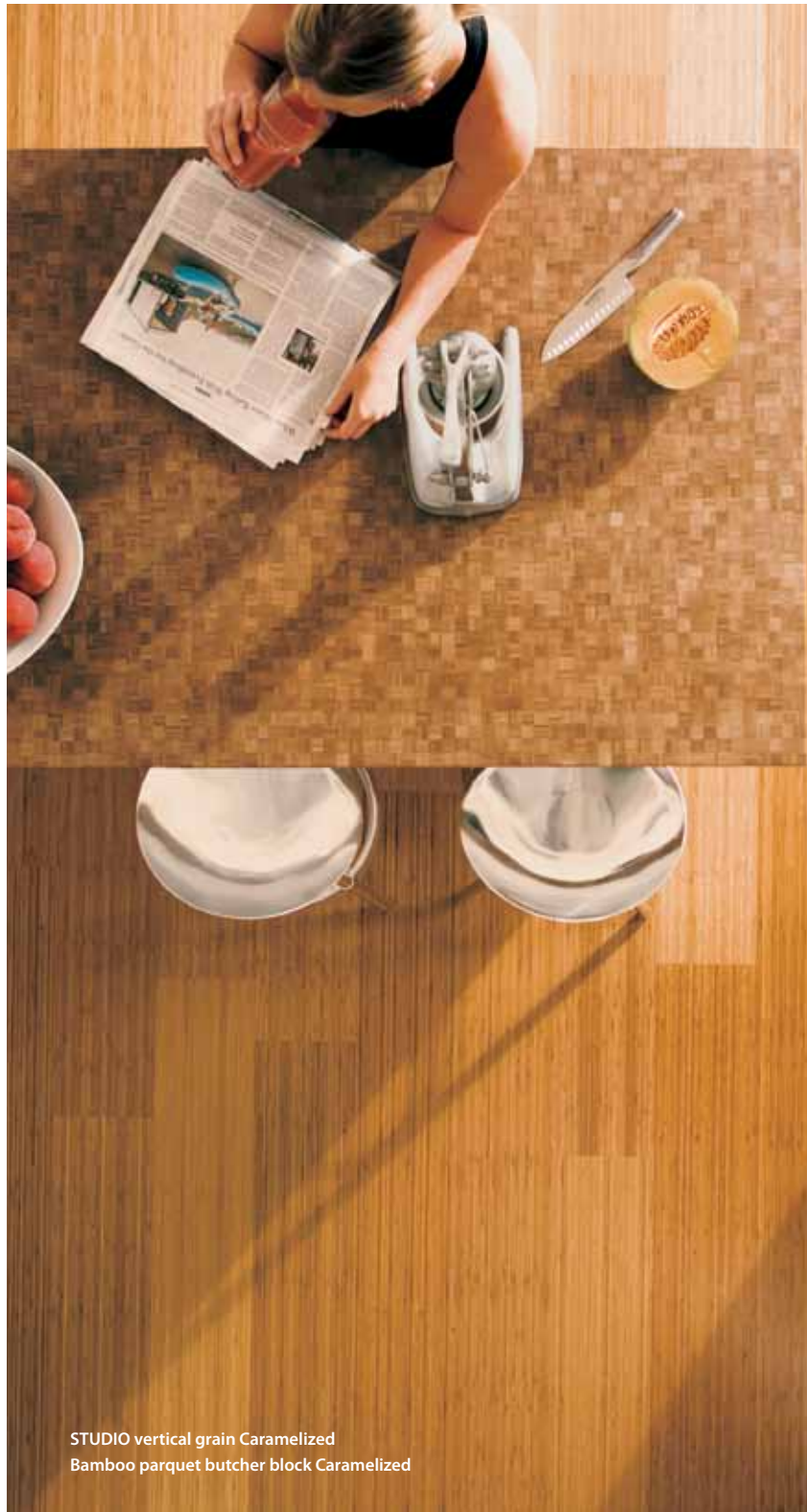

STUDIO vertical grain Caramelized
Bamboo parquet butcher block Caramelized

XCORA™
Technology

Our strand bamboo is created from a unique process, where the round bamboo culm is split into slats and shredded. The resulting bamboo strands are then infused with a proprietary adhesive before being loaded into our state-of-the-art hot press. Known as Teragren's Xcora manufacturing process, this is the very best in strand bamboo product engineering. As a result, our Portfolio and Synergy® strand bamboo products are 154 percent harder than red oak – perfect for high-traffic commercial and residential interiors.

SIGNATURE COLORS, Traditional solid-strip, prefinished, 3-5/8" x 5/8" x 24", 36", 48" and 72"



Signature Colors features our traditional flat grain bamboo flooring with one of four stains that subtly highlight the grain. The semi-transparent stain enhances the natural color variations in the bamboo.



- Micro-bevel on all four sides
- Tongue and groove
- Nail, staple or glue down
- Flat grain with stain colors

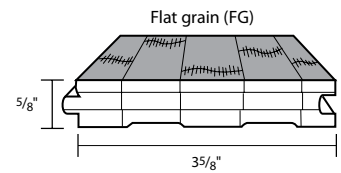
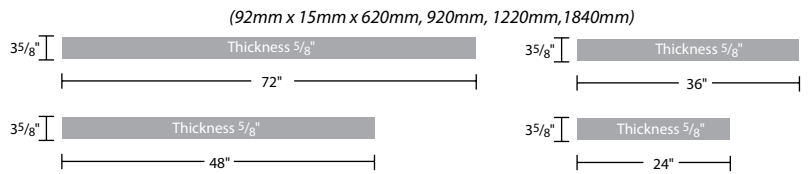

CRAFTSMAN II, Traditional, prefinished, long-plank, 5 1/2" x 5/8" x 75-1/2"

Craftsman II traditional bamboo flooring has a classic, wide scale. Its long planks anchor grand spaces with traditional flair.

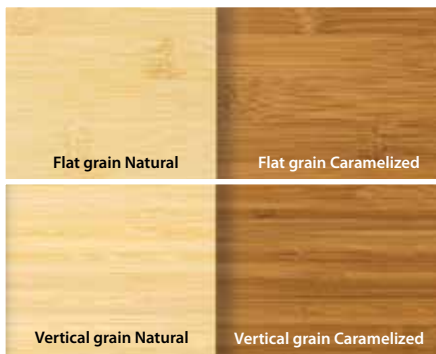

- Micro bevel on all four sides
- Tongue and groove
- Each box contains all 75-1/2" lengths
- Nail, staple, glue or float

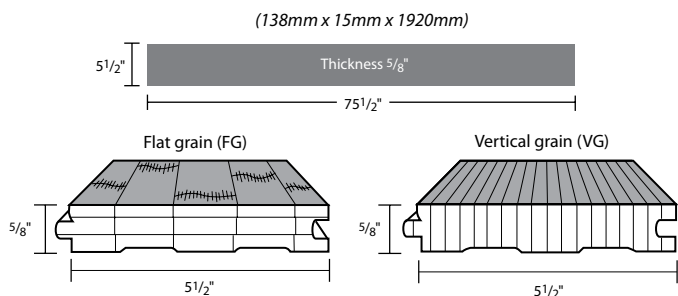

CRAFTSMAN II vertical grain Natural

SIGNATURE NATURALS, Traditional solid-strip, prefinished, 3-5/8" x 5/8" x 24", 36", 48" and 72"

The width and lengths are comparable to any traditional hardwood floor and work beautifully with any design. Signature Naturals is 25% harder than red oak - ideal for any room in the home or workplace.

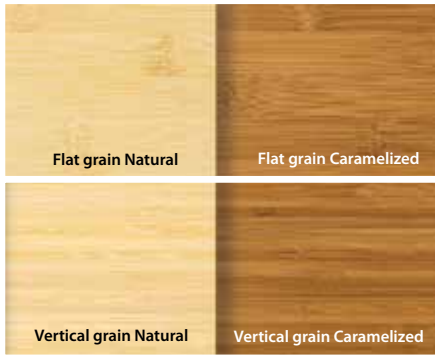

- Micro-bevel on all four sides
- Tongue and groove
- Nail, staple, or glue down

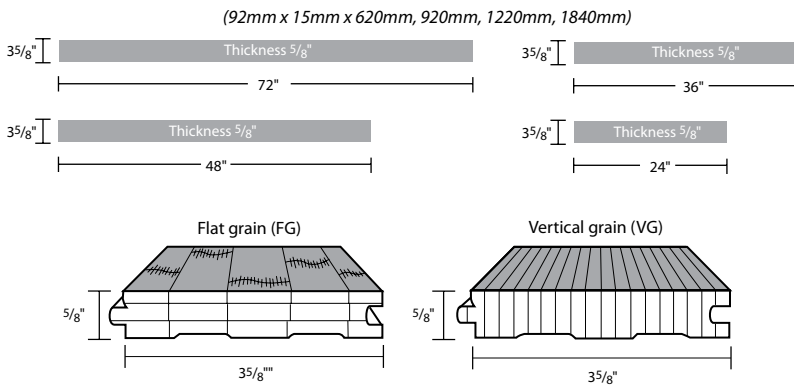

ELEMENTS, Solid-strip bamboo flooring in 3' lengths, 3-5/8" x 5/8" x 36"



Elements is designed to provide optimal affordability to homeowners as well as builders and developers. Wide color variation within and between planks highlights the natural contrast.

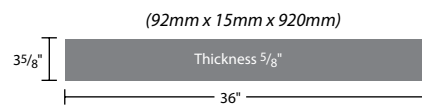
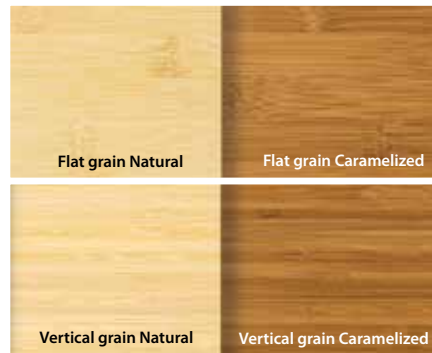

- Micro-bevel on all four sides
- Tongue and groove
- Each box contains all 36" lengths
- Nail, staple, or glue down

With a 16-year track record of providing high-quality bamboo products, Teragren is clearly the industry leader when it comes to bamboo flooring, panels and countertops.
 - Keith Rosen, Gensler Architects (NYC)

PRODUCT COMPARISON CHART

STRAND BAMBOO

PRODUCT	Portfolio Colors	Portfolio Naturals	Synergy® Wide Plank	Synergy® MPL	Synergy® 72
Length	72-1/2"	72-1/2"	72"	24", 36", 48", 72" in one carton	72"
Width	5"	5"	7-11/16"	3-3/4"	3-3/4"
Thickness	1/2"	1/2"	9/16"	1/2"	3/8"
Installation Method	Float	Float	Float	Nail/Glue	Glue
Construction	Solid Strand	Solid Strand	Cross-ply engineered strand	Solid Strand	Solid Strand
Milling	Micro-bevel	Micro-bevel	Square-edge	Micro-bevel	Micro-bevel
Profile	Fold-Down Locking	Fold-Down Locking	Self-locking	Tongue + Groove	Tongue + Groove
Hardness Rating*	3271	3271	3271	3271	3271
3-part CSI Spec	✓	✓	✓	✓	✓
LEED	MR6; IEQ 4.3	MR6; IEQ 4.3	MR6; IEQ 4.3	MR6; IEQ 4.3	MR6; IEQ 4.3
Coordinating Stair Parts	✓	✓	✓	✓	✓
Finish Warranty	25-yr residential 10-yr commercial	25-yr residential 10-yr commercial	25-yr residential 10-yr commercial	25-yr residential 10-yr commercial	25-yr residential 10-yr commercial

TRADITIONAL BAMBOO

PRODUCT	Studio	Craftsman II	Signature Colors	Signature Naturals	Elements
Length	75"	75-1/2"	24", 36", 48", 72" in one carton	24", 36", 48", 72" in one carton	36"
Width	7-11/16"	5-1/2"	3-5/8"	3-5/8"	3-5/8"
Thickness	9/16"	5/8"	5/8"	5/8"	5/8"
Installation Method	Float	Nail/Staple/Glue or Float	Nail/Staple/Glue	Nail/Staple/Glue	Nail/Staple/Glue
Construction	Cross-ply engineered traditional	Solid Traditional	Solid Traditional	Solid Traditional	Solid Traditional
Milling	Square-edge	Micro-bevel	Micro-bevel	Micro-bevel	Micro-bevel
Profile	Self-locking	Tongue + Groove	Tongue + Groove	Tongue + Groove	Tongue + Groove
Hardness Rating*	1492	1876	1876	1876	1876
3-part CSI Spec	✓	✓	✓	✓	✓
LEED	MR6; IEQ 4.3	MR6; MR7; IEQ 4.3	MR6; MR7; IEQ 4.3	MR6; MR7; IEQ 4.3	MR6; IEQ 4.3
Coordinating Stair Parts	✓	✓	✓	✓	✓
Finish Warranty	25-yr residential 10-yr commercial	25-yr residential 10-yr commercial	25-yr residential 10-yr commercial	25-yr residential 10-yr commercial	7-yr residential 3-yr commercial

COORDINATING BAMBOO ACCESSORIES

Complete your design with our extensive line of prefinished or site-finished accessories that coordinate with all Teragren bamboo flooring.

- PORTFOLIO COLORS*
- PORTFOLIO NATURALS*
- SYNERGY® WIDE PLANK*
- SYNERGY® MPL*
- STUDIO*
- CRAFTSMAN II*
- SIGNATURE COLORS*
- SIGNATURE NATURALS*

TRIM

Base Molding

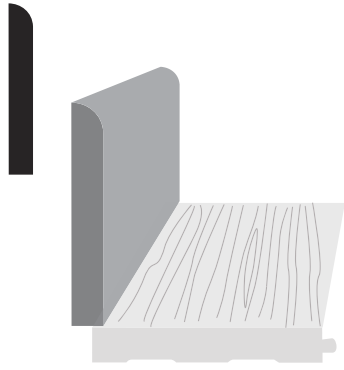

Base Molding

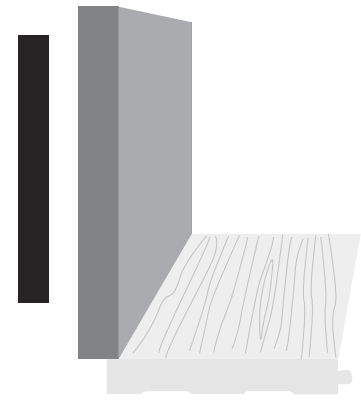

Base Shoe



Floor Vents

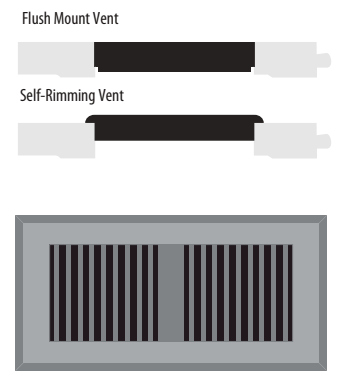

TRANSITION

Baby Threshold

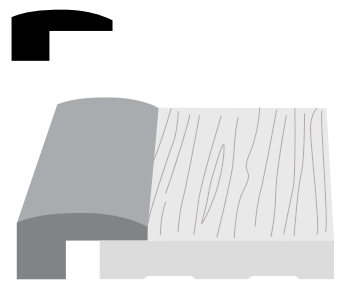

Clamshell Reducer

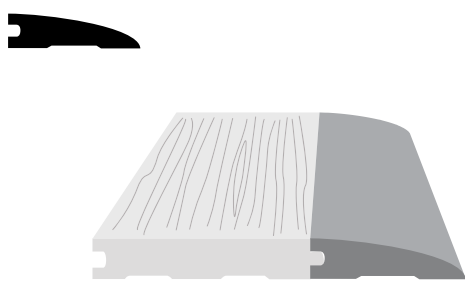

Floating Floor Reducer

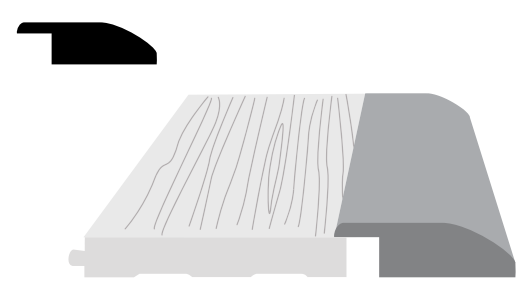

T-mold

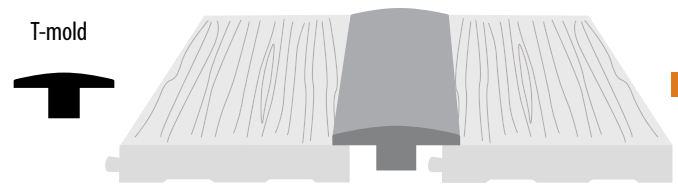

STAIR PARTS

Stair Nosing

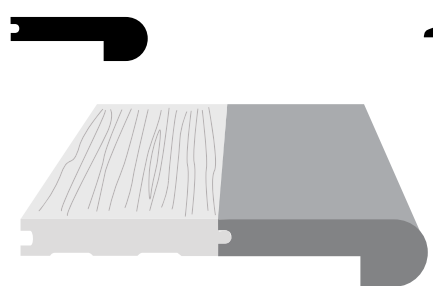

Stair Nosing for Floating Floors

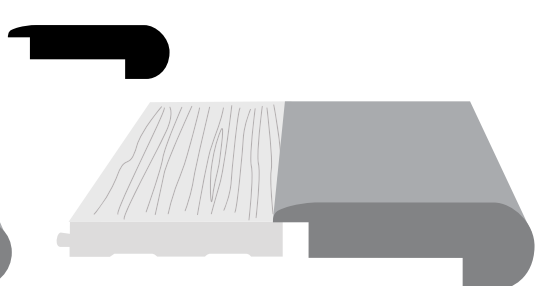

Stair Tread



Stair Riser



ECOSMART WORKTOPS

To help you complete your design, Teragren provides coordinating bamboo worktops to industry-leading and environmental standards.



Bamboo parquet butcher block, Caramelized

Teragren® Bamboo Parquet Butcher Block

Natural or Caramelized

- 30" x 96" x 1½" or 36" x 72" x 1½"
- Ideal for cutting surfaces and food prep areas
- Durable, end-grain parquet – harder than maple
- Prefinished with a food-safe mineral oil finish
- Also available unfinished

30" x 96" x 1½" (762mm x 2440mm x 38mm)

36" x 72" x 1½" (915mm x 1830mm x 38mm)



Natural

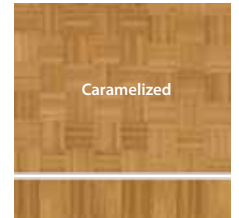

Caramelized



Vertical Grain Caramelized face with Chestnut strand core

Teragren® Traditional Bamboo Worktop

Vertical Grain Caramelized face with Chestnut strand bamboo core or

Vertical Grain Natural face with Wheat strand bamboo core

- 30" x 96" x 1½" or 36" x 72" x 1½"
- Prefinished with a food-safe mineral oil finish
- Also available unfinished

30" x 96" x 1½" (762mm x 2440mm x 38mm)

36" x 72" x 1½" (915mm x 1830mm x 38mm)

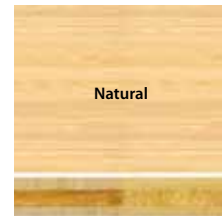

Natural

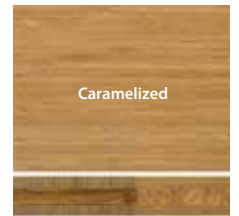

Caramelized



Chestnut strand face with Vertical Grain Caramelized core

Teragren® Strand Bamboo Worktop

Chestnut strand bamboo face with Vertical Grain Caramelized core or

Wheat strand bamboo face with Vertical Grain Caramelized core

- 36" x 72" x 1½"
- Ideal for kitchen counters, islands, table tops or other furniture applications
- 154% harder than red oak
- Unfinished

36" x 72" x 1½" (915mm x 1830mm x 38mm)



Wheat

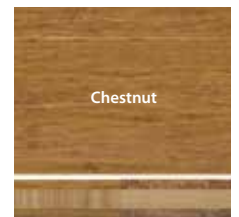

Chestnut

 Like us
www.facebook.com/
Teragren

 Follow us
www.twitter.com/
Teragren

 Watch us
www.youtube.com/
TeragrenBamboo

teragren.com

 **Teragren**®

12715 Miller Road NE
Suite 301
Bainbridge Island, WA
98110

800.929.6333 toll-free
206.842.9477 tel
206.842.9456 fax
info@teragren.com

2/12

